

Solar Battery 12V 250AH Sunipod VRLA-12V 250AH

Batteries designed with Absorbent Glass Material (AGM) battery technology specifically for solar power generation applications

HIGHLIGHTS

- Produced by state of the art know-how and made from most pure material.
- Long floating and cyclic life span, highest specific energy, low self-discharge rate, leak proof, anti-corrosion and good endurance of low and high temperature character.
- Heavy duty corrosion-resistant alloy for positive plates increase battery's cyclic life in tropical environments.
- Lower internal resistance and superior high-discharge performance.
- Flame retardant ABS container.
- Copper terminals.
- Proprietary paste recipe for excellent charge acceptance.
- Low self-discharge rates for long storage periods.
- Conform to international standards.

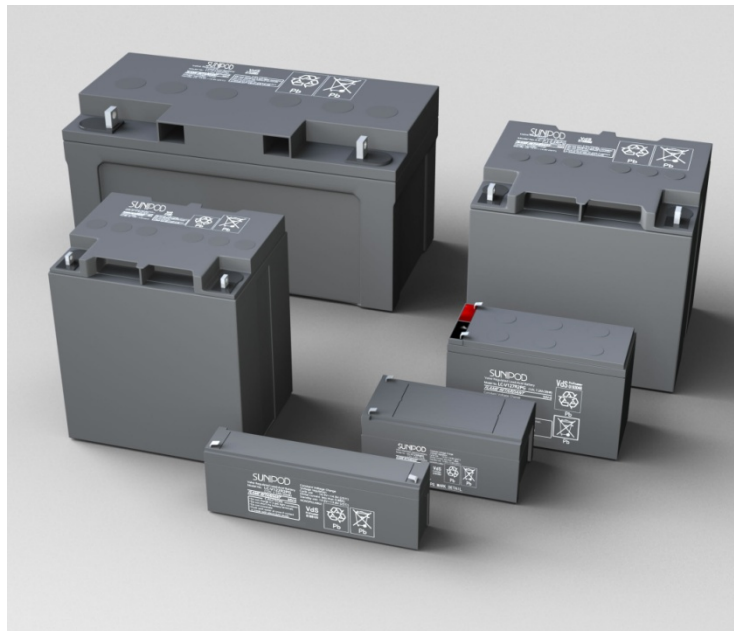

APPLICATIONS:

- Diesel Generator Alternative Using Solar Power Plants
- Lower Your Electric Bill Using Solar Power Stations

SPECIFICATIONS

Nominal Voltage	12V	
Capacity (10 hr, 25°C)	250Ah	
Dimension	Length	520 mm
	Width	268 mm
	Height	220 mm
	Total Height	243 mm
Approx. Weight	73 Kg	

CHARACTERISTICS

Capacity (25°C)	10 hour rate	250Ah
	5 hour rate	200Ah
	1 hour rate	150Ah
	1.5 hour discharge to 10.5V	100A

CHARACTERISTICS cont.

Capacity affected by temperature (10 hr)	40°C	102%
	25°C	100%
	0°C	85%
	-15°C	65%
Self-discharge (25°C)	3 month	Remaining Capacity: 91%
	6 month	Remaining Capacity: 82%
	12 month	Remaining Capacity: 64%
Nominal operating temperature	25°C±3°C	
Operating temperature range	-15°C to 50°C	
Float charging voltage (25°C)	13.60 to 13.80V	
Cyclic charging voltage (25°C)	14.50 to 14.90V	
Internal Resistance (Fully charged, 25°C)	Approx. 3 mΩ	

DIMENSIONS

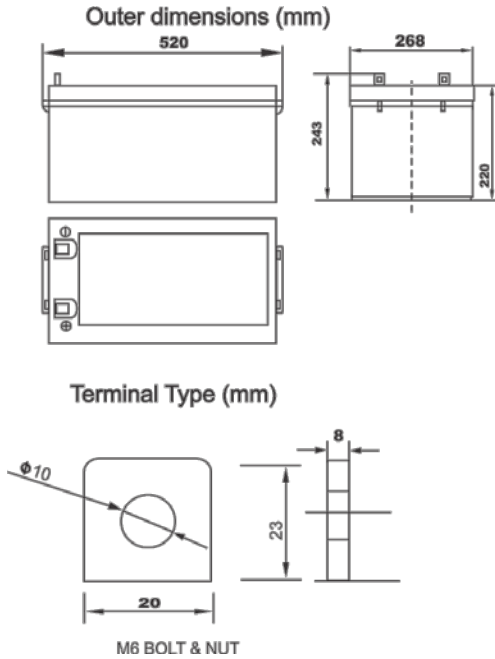

DISCHARGE CHARACTERISTICS (25°C)

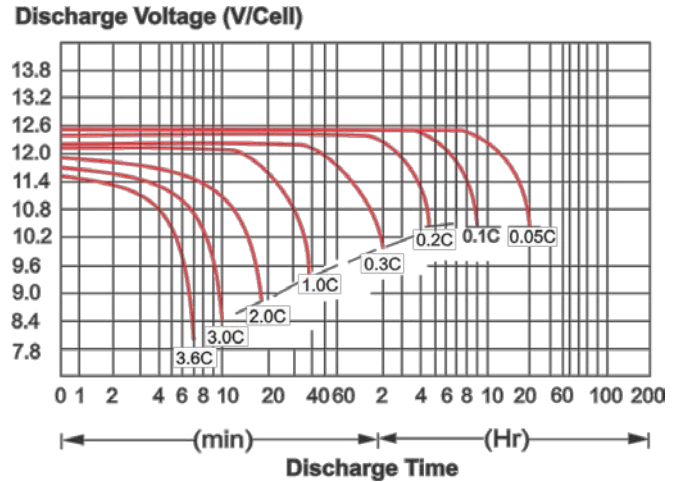

CHARGING CHARACTERISTICS (25°C)

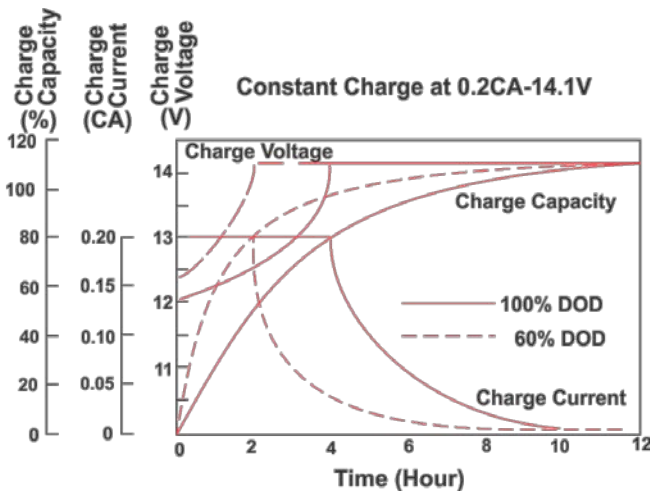

CYCLE LIFE (25°C)

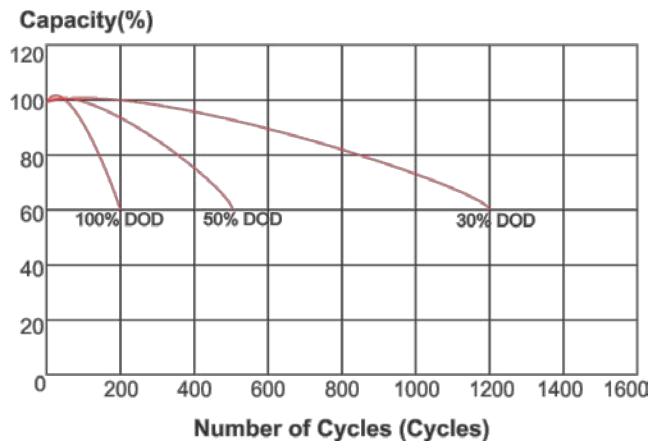

Specifications included in this datasheet are subject to change without notice. Electric data without guarantee.

Contact India Office:
 Victory Mansion, Sitaladevi Temple Road, Mahim, Mumbai – 400016
 Ph: 022-6464-9090

Contact US Office:
 509 Granger Terrace, Sunnyvale, CA – 94087
 Ph: +1-408-431-0408

